

## PRECI-FLEX® Adapter 32, Shrink Fit D8

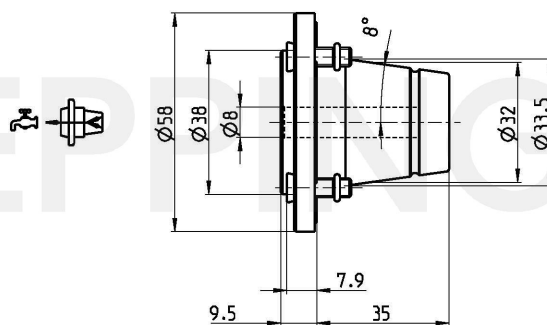

**Part Number 3214-0361**

Scope of Delivery **Fixing Screws 0.000.510**  
**O-Ring 11086**  
Accessories Screw Driver 0.001.076

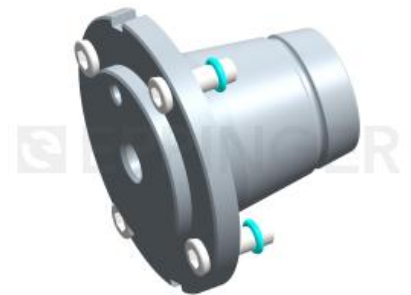

Technical Data Subject to Change

24.08.2012 | 22.11.2012

ESA Eppinger GmbH | Breitwiesenweg 2-8 | 73770 Denkendorf, Germany | [www.eppinger.de](http://www.eppinger.de)