

PRECI-FLEX® Adapter 32, Shrink Fit D6

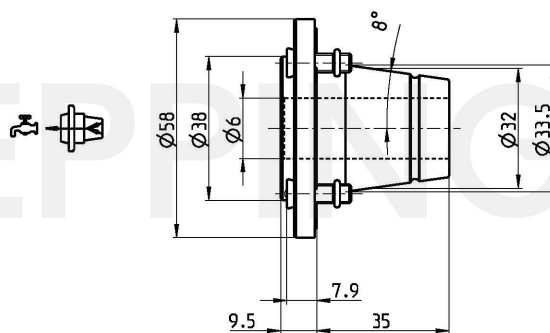

Part Number 3214-0360

Scope of Delivery **Fixing Screws 0.000.510**
O-Ring 11086
Accessories Screw Driver 0.001.076

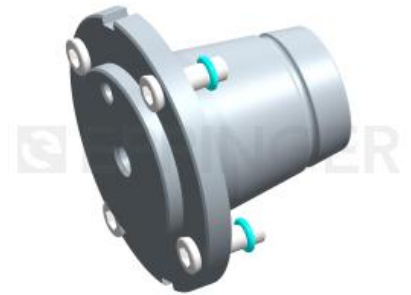

Technical Data Subject to Change

24.08.2012 | 06.09.2012

ESA Eppinger GmbH | Breitwiesenweg 2-8 | 73770 Denkendorf, Germany | www.eppinger.de