

PRECI-FLEX® Adapter 32, Whistle Notch extended DIN1835-E10

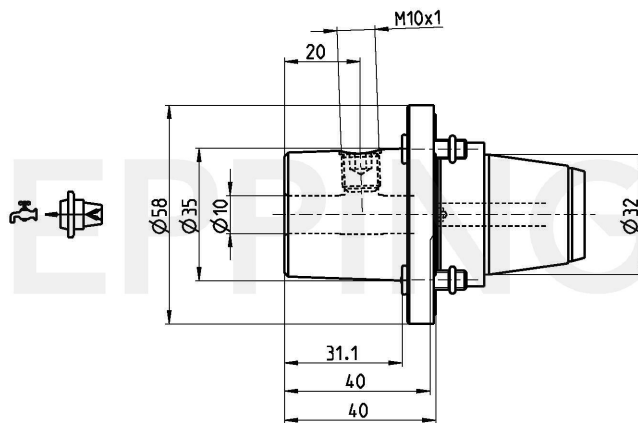

Part Number 3206-0052

Scope of Delivery **Fixing Screws 0.000.510**
O-Ring 11086
Accessories Screw Driver 0.001.076



Technical Data Subject to Change

24.08.2012 | 24.08.2012